



Cryo Bio System



CATALOGUE EN

Cryo Bio System was founded in 1987 and is the human division of IMV Technologies, world leader in the reproduction biotechnology market, based in l'Aigle (Normandy, France).

Exclusively dedicated to Life Science and Biodiversity, Cryo Bio System strives to provide scientists and physicians with IMV Technologies' expertise in the field of cryopreservation of biological samples, with innovative and High Security products for:

- Biorepositories, epidemiological research
- Blood transfusion haemovigilance
- Cell culture and genetic therapy units
- The pharmaceutical industry
- Assisted Reproductive Technologies
- Genomics and proteomics
- Medico-legal storage
- Military medicine
- Biodiversity (animal and plant-based germplasm conservation)

Cryo Bio System currently operates in over 80 countries through four subsidiaries in the USA, India, the Netherlands and China, as well as a network of efficient distributors, focusing on product quality and keeping close to its clients to best meet their requirements.

## Cryo Bio System...

High Security, a unique concept



### Safety

No risk of cross-contamination between samples, the outside environment (LN2) and the operator.



### Biocompatibility

Use of biocompatible, non toxic ionomeric resin, with no plastic agent or by-product.



### Traceability

Color code identification and LN2-proof printed labels/jackets (link with sample, patient's clinical and medical data).



### Optimization

Storage in straws or goblets for space optimization.

# Contents

---

## DEDICATED CONSUMABLES AND ACCESSORIES

CBS™ High Security sperm straws - sterile MD	6
For use with PACE and MAPI	6
For manual use with SYMS and SYMS III	7
CBS™ High Security non-sterile straws-non MD (Biobanking)	8
OTHER ACCESSORIES for sterile and non-sterile CBS™ High Security straws	8
CBS™ High Security Vitrification straw	10
CBS™ High Security Tube	12
LEJA slides	14
Injection, holding and biopsy pipettes SLM	15

## OTHER ACCESSORIES

Micro-aspirateur	18
Colored inserts / 2D inserts	18
ID rods for CBS™ 0.3 ml straws	19
Identification and obturating rods for PETG straws	19
Brady M210-LAB and M 510-EU-BWS printers	20

## STORAGE

CBS™ visotubes and daisy goblets	24
CBS™ Visotubes and standard goblets	25
Canisters	26
Identification rods for visotubes	27
Insulated transport box	27
Tweezers and forcep	

## EQUIPMENT

Nano-Digitcool	30
Controlled-rate freezers, Digitcool range	31
DIGITCOOL ALPHA CBS™ <b>NEW</b>	32
Craft™ pump	33
SYMS	33
SYMS III	34
SYSO	35
MAPI	36
PACE	37
Integral HSV	38
ULISS <b>NEW</b>	40

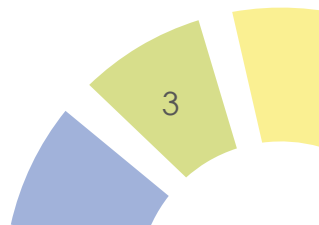





## CONSUMABLES AND DEDICATED ACCESSORIES

CBS™ High Security sterile sperm straws MD

CBS™ High Security non-sterile straws (BB)

Accessories for CBS™ straws

PETG sperm and embryo straws

CBS™ High Security Vitrification straws

CBS™ High Security Tube

LEJA slides

Injection, holding and biopsy pipettes

# CBS™ High Security sperm straws - sterile MD

Medical  
Device  
Classe IIa

CE marked



## DESCRIPTION

Human sperm freezing and cryopreservation.  
CBS™ High Security straws are made from a transparent ionomeric resin chemically inert and biocompatible. These straws are resistant and fully secured for LN2 storage.

## TECHNICAL CHARACTERISTICS

Length: 133 mm  
Internal diameter: 2.5 mm  
*Sterilization by irradiation.*

## For use with PACE and MAPI

### CBS™ High Security 0.3 ml sperm straw colored identification rod and white jacket 75\*

Red	White	Yellow	Blue	Green	Purple
017797 ●	017798 ○	017799 ●	017800 ●	017801 ●	017802 ●

\*Current packaging: 75 (5 x 15) - will be soon by 80: 4 x (4 x 5)

The CBS tubing allow the filling of the CBS™ HS straws with MAPI & PACE equipments

007454	Sterile CBS™ injection tubing (5 x10)		50
018620	Sterile CBS™ long blue injection tubing		25
007451	Sterile CBS™ suction tubing		50

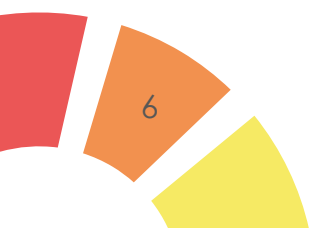

CE marked  
 FDA 510(k) premarket notification clearance for the USA # K002595

## For manual use with SYMS and SYMS III

<b>010287</b>	<b>CBS™ High Security 0.3 ml sperm straw with white plug</b>	<b>20</b>
<b>010288</b>	<b>CBS™ High Security 0.3 ml sperm straw with white plug</b>	<b>100</b>

<b>30 mm weighted identification rods for 0.3 ml straws</b>						<b>10</b>
Yellow	Green	Blue	Orange	White	Red	
<b>019021</b> ●	<b>019022</b> ●	<b>019023</b> ●	<b>019024</b> ●	<b>019025</b> ○	<b>019026</b> ●	
						<i>(Non MD accessories)</i>

<b>014651</b>	<b>CBS™ High Security 0.5 ml sperm straw with white plug</b>	<b>20</b>
<b>014650</b>	<b>CBS™ High Security 0.5 ml sperm straw with white plug</b>	<b>100</b>

<b>CBS™ High Security Sperm straw 0.5 ml colored plug</b>						<b>100</b>
Red	Yellow	Green	Blue	Orange	Grey	
<b>016584</b> ●	<b>016611</b> ●	<b>016612</b> ●	<b>016613</b> ●	<b>016614</b> ●	<b>016615</b> ●	

CONSUMABLES

<b>029308</b>	<b>Sterile filling nozzle for CBS™ High Security straw</b>	<b>100</b>
---------------	--	------------



The CBS™ filling nozzle ensures a leak-proof environment as it fully isolates the sealing zone from any contact with fluid as the biological sample is drawn in.

Medical Device  
 Classe IS



# CBS™ High Security non-sterile straws-non MD (Biobanking)

## DESCRIPTION

Cryopreservation of biological samples.

CBS™ High Security straws are made from a transparent ionomeric resin chemically inert and biocompatible. These straws are resistant and fully secured for LN2 storage.

## TECHNICAL CHARACTERISTICS

Length: 133 mm

Internal diameter: 2.5 mm

### CBS™ High Security 0.3 ml straw colored cotton plug and white jacket 300

Grey	Red	Green	Blue	Yellow	Orange	White
019046 ●	019047 ●	019048 ●	019049 ●	019050 ●	019051 ●	019052 ○



014623	Non-sterile injection tubing	200
018276	Blue CBS™ long injection tubing, non-sterile	200
014621	Buse d'aspiration non sterile suction tubing	200

## OTHER ACCESSORIES for sterile and non-sterile CBS™ High Security straws

014175	Permanent black markers	2
016731	Sterile connection tubing for syringe (pack of 5)	2 x 5
015047	Blue emptying rod for CBS™ High Security straws	1000

### Outer identification jacket 50

Red	White	Orange	Green	Blue	Yellow
010272 ●	010273 ○	010274 ●	010275 ●	010276 ●	010277 ●

# PETG sperm straw

RESEARCH  
ONLY

010261	Transparent PETG 0.25 ml sperm straw	100
014550	Transparent PETG 0.5 ml sperm straw	100
007342	Yellow sterile (13 mm) sealing and identification rods	40



## DESCRIPTION

PETG sperm straws are clear flexible straws made of a copolymer.  
Sales unit = bag of 100 sterile straws

## TECHNICAL CHARACTERISTICS

- 0.25 ml straw  
Length: 133 mm  
Internal diameter: 1.6 mm
  - 0.5 ml straw  
Length: 133 mm  
Internal diameter: 2.5 mm
- Sterilization by irradiation.*

# PETG embryo straw

RESEARCH  
ONLY

006433	Sterile clear rigid embryo straw 0.15 mL - 91 mm	100
006578	Sterile clear rigid embryo straw 0.25 mL - 133 mm	100
014102	Sterile clear flexible embryo straw 0.15 mL - 91 mm	100

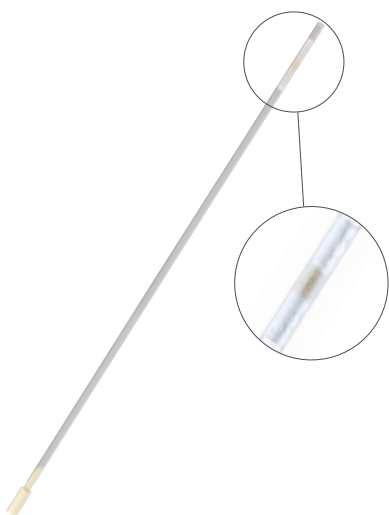

## DESCRIPTION

PETG embryo straws are flexible or rigid clear tubes made of copolymer.

*Sales unit = 5 trays of 4 x 5 straws*

## TECHNICAL CHARACTERISTICS

- 0,15 ml for 91 mm long straws
  - 0,25 ml for 133 mm long straws
- The internal diameter is 1.6 mm for both models.  
*Sterilization by irradiation.*

The 91 mm straws are closed with 42 mm identification rods and the 133 mm straws are closed with 13 mm identification and sealing rods (p.19)

CONSUMABLES

# CBS™ High Security Vitrification straw

Medical Device  
Classe IIa

CE marked



## DESCRIPTION

Vitrification of embryos (all stages) and oocytes.  
Exclusive High Security closed system.

The kit is comprised of 3 parts:

- a thin transparent High Security Vitrification ionomeric resin straw\*;
- a capillary tube with a transparent gutter and co-injected colored handling rod;
- a blue insertion device.

*Individually packaged. Blister pack of 4 kits.*

## TECHNICAL CHARACTERISTICS

*Sterilization by irradiation.*



*\*to be sealed with SYMS or SYMS III in standard use or with the HSV thermal hand-welder 028436 when used with the Integral vitrification unit*

### Blister of 4 CBS™ High Security Vitrification straws

Red	White	Yellow	Pink	Blue	Green
025246 ●	025247 ○	025248 ●	025249 ●	025250 ●	025251 ●

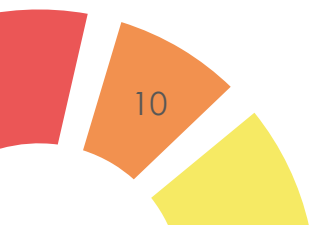

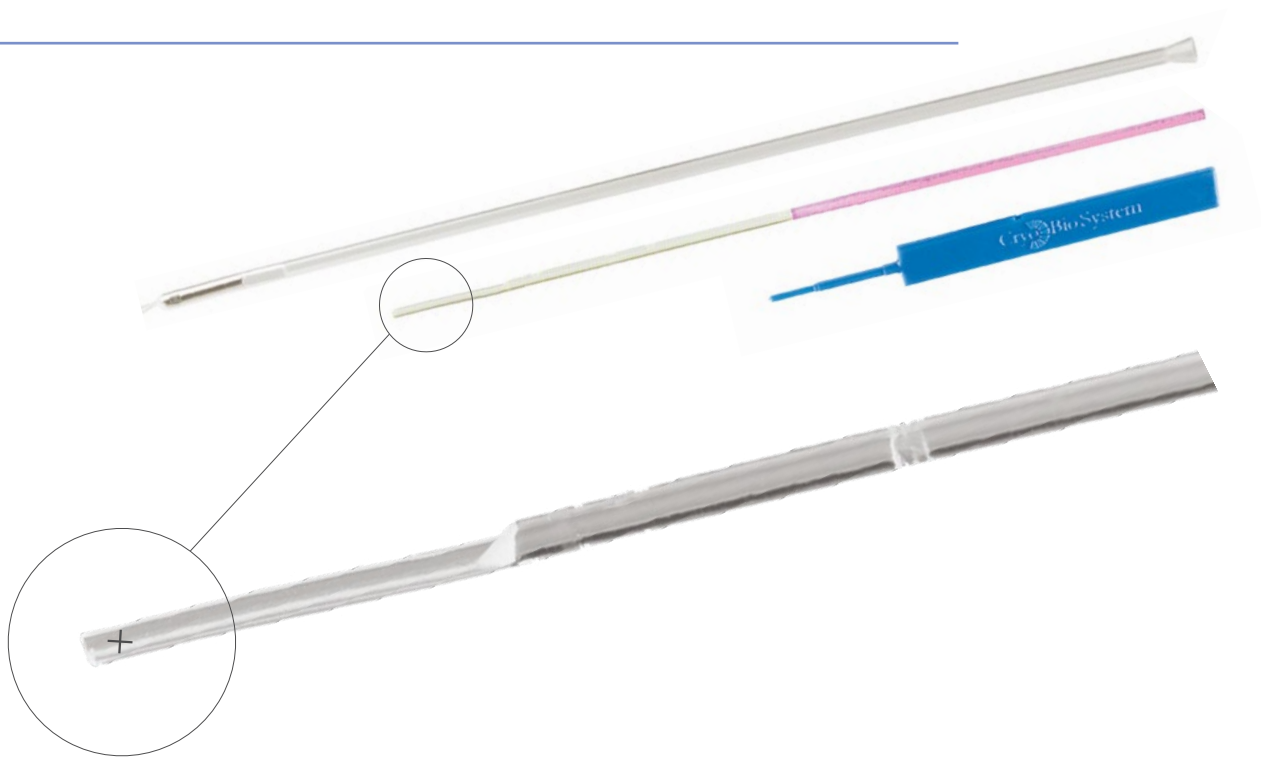

**022406** Opening tweezers for CBS™ High Security Vitrification straw



**027807** Integral HSV Vitrification Unit



Medical  
Device  
Classe I

#### DESCRIPTION

The INTEGRAL HSV vitrification unit is designed for vitrification, packaging and opening of CBS™ High Security Vitrification straws in the following applications:

- Reproductive Biology Laboratories
- Gamete banks.

**For more information: p.36-37**

**027636** Box of 5 opening devices for CBS™ High Security Vitrification straw

# CBS™ High Security Tube

**022252** Bag of 20 sterile CBS™ High Security Tubes  
**023722** Bag of 50 sterile CBS™ High Security tubes

Medical  
Device  
Classe IIa

**030055** Bag of 500 non-sterile CBS™ High Security tubes assembled with 2D data matrix coded white inserts - non sterile



## DESCRIPTION

The unique fully secured system for storage in liquid nitrogen.

CBS™ High Security tubes are derived from the CBS™ high security concept designed for optimum sample preservation. Made of biocompatible resin, CBS™ tubes eliminate concerns related to cross-contamination and issues induced by storage in liquid nitrogen.

Once sealed with the SYMS III sealer, the CBS™ High Security tube will be placed in storage boxes and in current storage systems.

## TECHNICAL CHARACTERISTICS

Usable working volume: 1.2 mL

Dimensions: 48 mm, Ø 11.8 mm

*Sterilization by irradiation.*



## SCOPE OF APPLICATION

- Preservation of fertility (ovarian and testicular tissue, sperm) for Assisted Reproductive Technologies
- Biological tissue banks for pharmaceutical, medical and scientific, biodiversity research
- Blood banks and blood transfusion centers
- Cell and genetic therapy (clinical phase and therapeutic applications)
- Packaging of vaccines and heat-sensitive drugs

## SAFETY

- Full seals eliminate all risk of cross-contamination of the sample and its environment
- Validated as leak-proof and shatter-proof in all cryogenic temperatures including liquid nitrogen phase
- Indestructible under normal conditions of use



#### TRACEABILITY OPTIONS

- Colored inserts for simple identification in cryogenic environments
- 2D data matrix coded white inserts
- Compatible with cryoresistant labels

#### COMPATIBILITY

- Standard racks, boxes (9x9 or 10x10), canes
- Manual or automatic filling systems
- Programmable freezers (URL link: Digitcool line)
- Cryogenic storage conditions for use in: liquid nitrogen, vapor phase, mechanical freezers

#### 024922 SYSO



#### DESCRIPTION

The SYSO opening device can be used under laminar flow and is designed to open CBS™ High Security tubes with a hot wire.

**For more information: p.38**

#### 023836 Autoclavable scissors for CBS™ High Security Tubes



# LEJA slides

## 026853

CE marked  
SC-10-01-04-B  
10 µm 4 wells - 4x25  
2 µl / analysis

## 025226

non CE

## 026854

CE marked  
SC-12-01-C  
12 µm 2 lateral wells - 4x25  
4 µl / analysis

## 026855

CE marked  
SC-20-01-C  
20 µm 2 lateral wells - 4x25  
6 µl / analysis

## 026354

Marquage CE  
SC-20-01-02-B  
20 µm 2 wells - 4x25  
6 µl / analysis

## 026355

CE marked  
SC-20-01-04-B CE  
20 µm 4 wells - 4x25  
3 µl / analysis

## 025107

non CE

## 026357

CE marked  
SC-100-01-02-A  
100 µm 2 high precision wells - 4x25  
30 µl / analysis

## 026043

Non CE  
SC-100-01-02-B  
100 µm 2 puits - 4x25  
30 µl / analyse

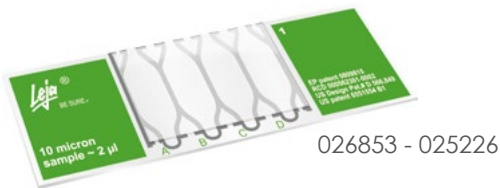

026853 - 025226



026854



026855

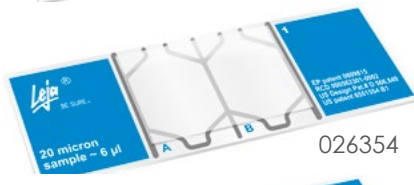

026354



026355 - 025107

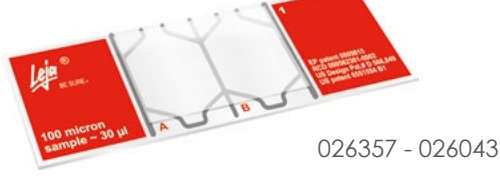

026357 - 026043

## DESCRIPTION

High quality disposable counting chambers for sperm analysis.

Due to their special characteristics, Leja slides will both save time and increase the level of accuracy and precision of sperm analysis.

All slides are covered with a special coating to prevent air bubbles and to prevent the sample from bonding to the chamber surface.

The resin and ink are both non toxic. Leja slides have an excellent low limit of quantification and can handle high sperm concentrations.

This has a direct clinical impact: you will be better prepared to determine the thresholds for the various procedures of Assisted Reproduction Technologies (waiting for natural conception, intrauterine insemination, in-vitro fertilization and intracytoplasmic semen injection) and to decide on the best treatment option for a couple.

The high level of accuracy and precision of the Leja slides will allow your results to be compared with scientific data from other laboratories in regards to the relationship between semen parameters (concentration, motility, viscosity) and fertility.

## TECHNICAL CHARACTERISTICS

Slides with 2 or 4 chambers CE or non CE marked

Depth: 10, 12, 20 or 100 microns



# Injection, holding and biopsy pipettes SLM

CE marked

Their unique shape and taper provide for smooth movement of its content.  
*Individually packed in boxes of 10 units. Made of borosilicate glass.*  
*Sterilization by irradiation.*

## PIPETTES D'INJECTION

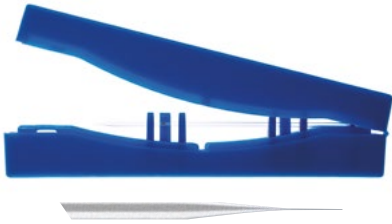

<b>022166</b>	<b>Injection pipette – 20° angle</b>	<b>10</b>
<b>022167</b>	<b>Injection pipette – 30° angle</b>	<b>10</b>

### DESCRIPTION

Injection pipettes are used to perform intracytoplasmic sperm injection (ICSI).

## HOLDING PIPETTE



<b>022168</b>	<b>Holding pipette – outer ø 100 µm – 20° angle</b>	<b>10</b>
<b>022169</b>	<b>Holding pipette – outer ø 100 µm – 30° angle</b>	<b>10</b>
<b>022170</b>	<b>Holding pipette – outer ø 120 µm – 20° angle</b>	<b>10</b>
<b>022171</b>	<b>Holding pipette – outer ø 120 µm – 30° angle</b>	<b>10</b>

### DESCRIPTION

Holding pipettes are designed to hold an oocyte or embryo in position during ICSI and other micromanipulation procedures.

## BLASTOMERE BIOPSY PIPETTES & POLAR BODY BIOPSY PIPETTES



<b>028209</b>	<b>Pipette for blastomere biopsy – 20° bevelled angle</b>	<b>10</b>
<b>022172</b>	<b>Pipette for blastomere biopsy – 30° flat angle</b>	<b>10</b>
<b>030122</b>	<b>Polar Body Biopsy Pipettes – 20° flat angle with spike ti</b>	<b>10</b>

### DESCRIPTION

The biopsy pipettes are designed to remove blastomeres or polar body from embryos for preimplantation genetic diagnosis (PGD).

	Angle	Inner diameter	Outer diameter	Tip to angle length
<b>Injection</b>	20° / 30°	4,5-5,0 µm	7 µm	0,55 mm
<b>Holding</b>	20° / 30°	15-20 µm	100-119 µm / 120-130 µm	0,65 mm
<b>Blastomere biopsy</b>	20° / 30°	28-32 µm	31-35 µm	0,55 mm
<b>Polar body biopsy</b>	20°	15 µm	N/A	N/A

CONSUMABLES





## OTHER ACCESSORIES

Micro-aspirator / 2D and colored inserts  
Identification rods for CBS™ 0.3 ml straws  
Identification and obturating rods for PETG straws  
Brady M210-LAB & M510-EU-BWS printers

# Micro-aspirateur

014498 Micro-aspirator (comes with two adapters and tubing)



## DESCRIPTION

Manual straw filling.

The micro-aspirator is used to manually fill all straws manufactured by Cryo Bio System without any risk of contamination.

014500 Additional adapter and tubing for micro-aspirator

## Colored inserts / 2D inserts

### Bag of 500 non sterile inserts for CBS™ High Security Tubes

White

024108 ○

Blue

024109 ●

Green

024110 ●

Yellow

024111 ●

Red

024112 ●

Pink

024113 ●



**NB** : 2D inserts available already assembled with non sterile CBS™ tubes in bags of 500  
*More information on pages 12-13*

## ID rods for CBS™ 0.3 ml straws

### 30 mm weighted ID rod (for CBS 0.3 ml straws)

10

Yellow 019021 ● Green 019022 ● Blue 019023 ● Orange 019024 ● White 019025 ○ Red 019026 ● (Non-MD accessories)

### 029308 Sterile filling nozzle for CBS™ High Security straw

100



The CBS™ filling nozzle ensures a leak-proof environment as it fully isolates the sealing zone from any contact with fluid as the biological sample is drawn in.

Medical Device Class IS

## Identification and obturating rods for PETG straws

### Blister pack of 20 sealing and identification rods (42 mm) for 91 mm PETG straws

20

Yellow 007437 ● Violet 007438 ● Red 007440 ● Orange 007442 ● Pink 014484 ●  
 Blue 014485 ● Grey 014486 ● Green 014487 ● Royal Blue 014488 ● White 014489 ○

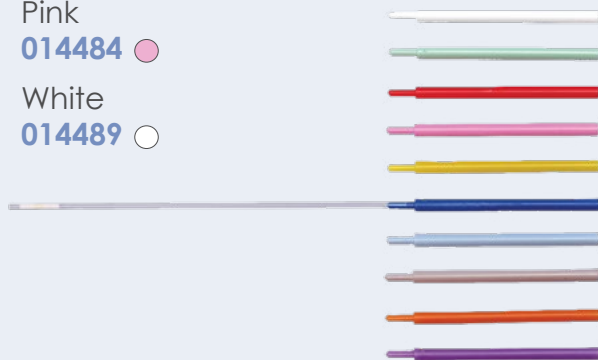

### 007342 Blister pack of 40 sterile yellow sealing and identification rods (13 mm) for 133 mm PETG straws

# Brady M210-LAB and M 510-EU-BWS printers

029570 M 210-LAB printer  
030357 M 510-EN-BWS printer



M 210-LAB



M 510-EU-BWS

## DESCRIPTION

Identification of CBS™ High Security and CBS™ High Security Vitrification straws for M 210-LAB and M 510-EN-BWS. Additional option of CBS™ tube identification with the M 510-EN-BWS.

## TECHNICAL CHARACTERISTICS

Print method: thermal transfer (lasting, no smearing).  
Multiple line printing.

### M 210-LAB PRINTER

L x W x H: 241 x 114 x 63 mm  
Weight: 0,750 kg

### M 510-EU-BWS PRINTER

L x W x H: 254 x 146 x 95 mm  
Weight: 1,380 kg

## M 210-LAB

- 024500 220V adapter for BMP 21 & M210 LAB printers
- 024501 White polyester ribbon 9.5mm for BMP 21 & M 210-LAB printers
- 025453 White polyester ribbon 12,7 mm for BMP 21 & M 210-LAB printers

## M 510-EU-BWS

- 025450 Self-protected large label for CBS™ tube
- 025451 Self-protected small label for CBS™ tube
- 026433 White polyester ribbon 9,53 mm for BMP 51 & M 510-EU-BWS printers
- 026434 White polyester ribbon 12,7 mm for BMP 51 & M 510-EU-BWS printers



SECURITY



OPTIMIZATION



BIOCOMPATIBILITY



TRACEABILITY



## STORAGE

Visotubes and goblets  
Canisters  
Identification rods for visotubes  
Insulated transport box  
Tweezers and forceps

# CBS™ visotubes and daisy goblets



## DESCRIPTION

Freezing of biological samples in liquid nitrogen in straws, sorted by color codes. CBS™ High Security straws are inserted in visotubes, which are housed in colored goblets prior to being stored in the cryopreservation units. Goblets come in 8 different colors and their sub-compartments (visotubes) come in 12 different colors.

The Daisy goblet holds 12 visotubes and can hold a maximum of 168 CBS™ High Security 0.3 and 0.5 mL straws.

## TECHNICAL CHARACTERISTICS

Diameter: 65 mm (67 mm with lid)

Goblet height: 117 mm

Total height of the Daisy goblet (with cover): 135 mm

Height of triangular visotubes: 120 mm

Height of round visotubes with 17.5 mm diameter: 133 mm

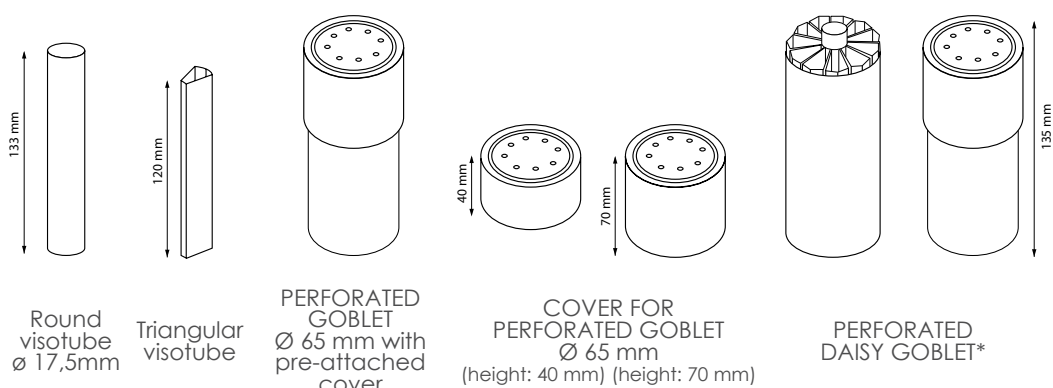

COLORS	COLORS		PERFORATED GOBLET Ø 65 mm with pre-attached cover			COVER FOR PERFORATED GOBLET Ø 65 mm (height: 40 mm) (height: 70 mm)		PERFORATED DAISY GOBLET*	
	Color	Code	006924	-	021224	021366	006321	015144	015152
Transparent	○	006924	-	021224	021366	006321	015144	015152	
Black	●	-	018153	-	-	-	-	-	
Brown	●	-	018147	-	-	-	-	-	
Red	●	-	018146	021228	-	-	015146	015154	
Green	●	-	018145	021226	-	-	015147	015155	
Blue	●	-	018148	021225	-	-	015151	015159	
Grey	●	-	018144	026948	-	-	018141	018142	
Violet	●	-	018152	021229	-	-	015150	015158	
Yellow	●	-	018143	021227	-	-	015148	015156	
Pink	●	-	018149	-	-	-	-	-	
Orange	●	-	018150	-	-	-	-	-	
Pistachio	●	-	018151	026949	-	-	015149	015157	
PACKAGING			100	100	10	50	10	1	5
CAPACITY	PETG 0.25 mL straw		55	45	820	-	-	540	540
	PETG 0.5 mL straw		20	20	365	-	-	240	240
	HSV CBS™ High Security straw		20	20	365	-	-	240	240
	High Security CBS™ straw		14	14	225	-	-	168	168

\* With 11 coloured triangular visotubes, 1 clear round visotube and 1 clear cover

NB: The perforated covers are designed for exclusive use with the perforated daisy goblets in Biobanking applications for long-term storage without daily handling.

# CBS™ visotubes and standard goblets











## DESCRIPTION

Freezing and storage of biological materials in straws. Arrangement using color coding of straws prior to storage in liquid nitrogen.

- Standard goblet Ø 35 mm  
Diameter: 35 mm  
Height: 122 mm
- Standard goblet Ø 65 mm  
Diameter: 65 mm  
Height: 117 mm
- Polygonal, hexagonal and round visotubes  
Height: 120 mm

All visotubes are also available in bags of 300 units (in identical colors and diameters).

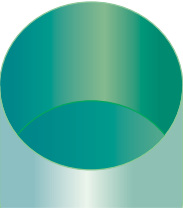
											STORAGE
		Polygonal visotube	Hexagonal visotube	Round visotube Ø 7,1 mm	Round visotube Ø 9,2 mm	Round visotube Ø 10 mm	Round visotube Ø 12 mm	Round visotube Ø 13 mm	Goblet Ø 35 mm	Goblet Ø 65 mm	
C O L O R S	White ○	020470	020486	020492	020499	020505	020511	020517	020523	024392	
	Blue ●	020472	020487	020493	020500	020506	020512	020518	-	006755	
	Green ●	020482	020488	020494	020501	020507	020513	020519	-	006754	
	Yellow ●	020483	020489	020495	020502	020508	020514	020520	-	006756	
	Orange ●	020484	020490	020496	020503	020509	020515	020521	-	-	
	Red ●	020485	020491	020497	020504	020510	020516	020522	-	006397	
	Violet ●	-	022141	-	-	-	-	-	-	006757	
Pistachio ●	-	-	-	-	-	-	-	-	006753		
<b>PACKAGING</b>		10	10	10	10	10	10	10	10	10	
C A P A C I T Y	PETG straw 0.25 mL	30	90	7	10	14	22	27	200	820	
	PETG straw 0.5 mL	15	36	2	5	5	8	10	94	365	
	HSV CBS™ High Security straw	14	36	3	6	6	10	12	-	-	
	CBS™ High Security straw	8	22	1	3	4	7	7	75	225	
	In a goblet Ø 35 mm	4	1	15	10	8	5	5	-	-	
	In a goblet Ø 65 mm	15	7	60	37	31	21	19	-	-	

# Canisters



## DESCRIPTION

Canisters are cylindrical racks for keeping goblets in liquid nitrogen or nitrogen vapors. The goblet and canister storage concept is compatible with all types of nitrogen and electric freezers.

Five canister lengths are available, with a capacity of between 2 and 6 goblets. A colored flag can be placed on the lifter (a bent metal rod to lift the stack of goblets) for quick identification of each canister.

Canisters are stored in the nitrogen freezer before filling it with liquid nitrogen.

Goblets are stacked and removed one by one with the lifter. Goblets must be handled in the cold environment of the neck of the nitrogen freezer to ensure even sample temperature.

## TECHNICAL CHARACTERISTICS

Diameter: 70 mm

<b>Canister with handle for standard goblets ø 65 mm without cover</b>					<b>1</b>
2-shelf	3-shelf	4-shelf	5-shelf	6-shelf	
<b>018342</b>	<b>018341</b>	<b>018340</b>	<b>018339</b>	<b>018127</b>	

<b>Canister with handle and white flag for Daisy goblets</b>					<b>1</b>
2-shelf	3-shelf	4-shelf	5-shelf	6-shelf	
<b>008644</b>	<b>008645</b>	<b>008646</b>	<b>007198</b>	<b>007199</b>	

<b>Plastic handle (colored flag for handle identification)</b>					<b>10</b>
White	Yellow	Salmon	Pink	Dark green	
<b>007328</b> ○	<b>015693</b> ●	<b>015694</b> ●	<b>015695</b> ●	<b>015696</b> ●	
Turquoise	Orange	Violet	Grey	Red	
<b>015697</b> ●	<b>015698</b> ●	<b>015699</b> ●	<b>015706</b> ●	<b>015700</b> ●	

<b>014175</b>	<b>Permanent black markers</b>	<b>2</b>
<b>022112</b>	<b>Rack for 24 daisy goblets</b>	<b>1</b>
<b>021998</b>	<b>Rack for 24 daisy goblets</b>	<b>1</b>
<b>007136</b>	<b>Work basket 3 places for 65 mm goblets</b>	<b>1</b>
<b>007145</b>	<b>Aluminium identification plate (without colored flag)</b>	<b>100</b>



## Identification rods for visotubes





### DESCRIPTION

These ID rods are a little bit longer than straws and are used to identify individual visotubes.











#### Medium identification rods for visotubes

100

Yellow 006331 	White 006762 	Red 006763 	Grey 006774 	Orange 006775 	Pink 006876 
--	---	---	---	--	--

#### Mini identification rods for visotubes

100

White 006330 	Yellow 006332 	Red 006777 	Pink 006779 	Orange 006786 	Grey 006787 
Blue 006782 	Pistache 006783 	Turquoise 023872 	Purple 023871 	Mastic 023870 	

007144 Cross-separator plates for 65 mm gobelets

1

## Insulated transport box

015937 Bag of 5 insulated boxes



### DESCRIPTION

Sperm transport prepared for intrauterine insemination. HDPE box with a precut polyurethane foam to hold a tube. These dimensions are compatible with all round or cone-shaped 5-15 mL culture tubes.

### TECHNICAL CHARACTERISTICS

Length: 120 mm  
Diameter: 65 mm

## Tweezers and forceps

026923 Brucelle tweezers - 14 cm

026924 Medium forceps - 23 cm

026925 Long forceps - 110 cm



## EQUIPMENT

Nano-Digitcool  
Controlled-rate freezers, Digitcool range  
DIGITCOOL ALPHA CBS™

Craft™ pump

SYMS

SYMS III

MAPI

PACE

Integral HSV

SYSO

ULISS



CE marked

**025680 Nano-Digitcool**



## DESCRIPTION

The compact controlled rate freezer solution for daily use for all cryopreservation applications. Digitcool freezers are used for controlled-rate freezing of biological samples (plasma, blood cells, tissue, gametes, etc.). Stainless steel Digitcool freezers are easy to maintain and disinfect. They are easy to set up and allow the user to optimally control the various protocols.

- Vertical nitrogen flow with vaporization
- Standalone operation available (emergency mode without IT)
- Traceability: CryoBioSoft software (aligned CFR21)
- Freezing of bags, straws, tubes, etc.
- Display of freezing phases, results and archiveset des archives

## TECHNICAL CHARACTERISTICS

Weight: 55 Kg

Dimensions: 772 x 475 x 472mm

Chamber dimensions (inside): 238 x 178 x 200mm

Volume: 11.5 L

Capacity:

- 33 CBS™ High Security straws
- 192 CBS™ High Security Tubes
- 15 DF200 bags

Power: 1200 W

Voltage: 220 V / 50Hz / 8 A



**025433 96 CBS™ tubes rack for Nano-Digitcool**

**024572 Straws rack for Nano-Digitcool**

**025327 DF 200 bags rack for Nano-Digitcool**

# Controlled-rate freezers, Digitcool range

007209 Digitcool  
007210 Mini-Digitcool

007208 Micro-Digitcool  
025680 Nano-Digitcool



## DESCRIPTION

Digitcool freezers are used for controlled-rate freezing of biological samples (plasma, blood cells, tissue, gametes, etc.). Stainless steel Digitcool freezers are easy to maintain and disinfect. They are easy to set up and allow the user to optimally control the various protocols.

## AVANTAGES

- Temperature range: +50°C to -150°C
- Cooling rate: 0.1 to 60°C/min
- Automatic reheating, drying and return to room temperature at the end of the cycle
- Programmer/regulator, hot/cold regulator and plug-in
- Temperature measured by PT 100 ohm (chamber and product)
- Digital temperature display (chamber, program)
- Can be connected to a computer terminal (portable or desktop) with control using the Cryobiosoft software package
- Regulation based on "chamber" temperature
- Liquid nitrogen dispensed through a self pressurized reservoir with a 60 or 120 liter capacity (with minimum pressure of 1 bar)

	Digitcool	Mini-Digitcool	Micro-Digitcool	Nano-Digitcool
<b>External dimension</b>	1170x800x1000mm	770x510x730mm	600x380x520mm	722x475x472mm
<b>Weight</b>	130 kg	58 kg	38 kg	55 kg
<b>Internal dimension</b>	960x470x320mm	640x320x420mm	490x325x230mm	238x178x200mm
<b>Volume</b>	150 L	90 L	26 L	11.5 L
<b>Sample capacity</b>	3 000 CBS™ straws 2304 CBS™ tubes 32 DF200 bags / 32 DF700 bags	1 392 CBS™ straws 576 CBS™ tubes 32 DF200 bags / 16 DF700 bags	240 CBS™ straws 192 CBS™ tubes 15 DF200 bags / 9 DF700 bags	33 CBS™ straws 192 CBS™ tubes 15 DF200 bags
<b>Power</b>	2500 W	2000 W	1000 W	1200 W
<b>Voltage</b>	220V/50Hz/16A	220V/50Hz/10A	220V/50Hz/6A	220V/50Hz/6A

025433 96 CBS™ tubes rack for Digitcool range  
025109 9 pouches rack 150 mL for Micro-Digitcool

*For the other racks and accessories of this range, please contact us.*

**030143** Digitcool ALPHA CBS™

**030155** Accessory kit (already included in the Digitcool Alpha Ref. Nr. 030143) : protective apron, gloves and undergloves, visor, 2 oxygenometers and stainless trays of various sizes – Quantity: 1



## TECHNICAL CHARACTERISTICS

- Dimensions (L x W x H): 1543 × 819 × 1087 mm
- Weight: > 350 kg
- Voltage: 220 V – 50 Hz or 208 V – 60 Hz
- Recommended LN2 pressure: 1 bar

## PERFORMANCES :

- Improved freezing uniformity thanks to the homogeneous nitrogen flow in the chamber.
- Chimney effect optimized by reorganizing the internal chamber.
- Carefully selected ventilation and blades → better homogeneity and precise speed control.
- Enhanced insulation → reduced heat loss.
- Reduced energy consumption.

## DESCRIPTION

The Digitcool Alpha CBS™ is a programmable workstation for the handling and cryopreservation of sensitive and valuable biological samples.

It offers a secure and ergonomic workstation, optimal cooling uniformity, and a simple and intuitive interface, combining performance, reliability, and enhanced safety for both the user and the biological samples.

- Workstation with secure and motorized cover (easy opening with foot pedal).
- Heated surface to prevent frostbite and extend the life of the lid seal.
- Light indicators (color coding) to signal functional status, alarms and power outages.
- Integrated backup power supply (UPS) to ensure safe operation and protect samples in case of power failure.
- Controlled nitrogen flow with high-precision PID regulation for optimal temperature stability.
- Simple and intuitive MMI interface: programming, protocol management and reporting.

# Craft™ pump

## 005553 Craft™ pump - Rocket vacuum pump (comes with accessories)



### DESCRIPTION

Aspiration of follicular fluid and oocytes. The Craft™ pump is specially designed for gentle and controlled aspiration, at a preset negative pressure, of oocytes by follicular aspiration.

### TECHNICAL CHARACTERISTICS

Dimensions (L x W x H): 20 x 14 x 12 cm

Weight: 3.2 kg.

Pressure: 0 - 400 mm Hg

- 015621 Craft™ pump foot switch
- 029813 Water trap set for Craft™ suction pump

# SYMS

## 016399 SYMS sealer



### DESCRIPTION

Manual sealer for CBS™ High Security straws. Cryo Bio System has developed a sealer for CBS™ High Security straws in ionomeric resin. The sealer is connected to the mains and operated by a push-button or foot switch (optional) as desired.

### TECHNICAL CHARACTERISTICS

Dimensions (L x W x H): 230 x 220 x 170 mm

Weight: 6 kg

Power supply : 220 V / 60 or 50 Hz

## 009848 SYMS spare parts kit (Teflon, fuse...)

CE marked

## 025547 SYMS III sealer



### DESCRIPTION

Sealer for CBS™ High Security straws, tubes and vitrification straws.

The SYMS III sealer is designed to heat seal CBS™ High Security 0.3 ml, 0.5 ml and CBS™ High Security Vitrification straws, and the CBS™ High Security tube, for optimal cryopreservation of biological samples.

### TECHNICAL CHARACTERISTICS

Dimensions (L x W x H): 335 x 250 x 105 mm

Weight: 3 kg

Power supply: 110 or 220 V / 60 or 50 Hz



### FEATURES

- Multilingual interface (French, English, Spain and Chinese) + 4 optional languages
- Color touch screen compatible with the use of laboratory gloves
- Machine cycle display: pre-heating, ready status and sealing in progress
- Two sealing modes: automatic detection or operator-controlled via the touch screen
- Fault signal with messages and alarms
- Display and tracking of maintenance modes
- Easy to clean and service.

## 026550 Set of sealing jaws for SYMS III

024922 SYSO



## DESCRIPTION

Automatic CBST™ High Security tube opening device.

The SYSO opening device can be used under laminar flow and is designed to open CBST™ High Security tubes with a hot wire.

- The carousel can hold up to 6 CBST™ High Security tubes (opening individually or in succession).
- User-friendly touch screen
- 8 languages available
- The wire is systematically sterilized by pyrolysis after each tube is opened.

## TECHNICAL CHARACTERISTICS

Dimensions (L x W x H): 358 x 275 x 157 mm

Weight: 2.5 kg

Power supply: 110 or 220 V / 60 or 50 Hz

## FEATURES

The SYSO opening machine is a worktop device for lab benches which can be used under laminar flow. It uses a hot wire to open CBST™ High Security Tubes and has applications which include:

- Epidemiological research departments
- Biobanks
- Serum banks
- Cellular and gene therapy units
- Vaccine-manufacturing pharmaceutical companies (living cells)
- Gene banks (animal, plant, microbiological)
- Reproductive biology laboratories
- Gamete and gonadal tissue banks

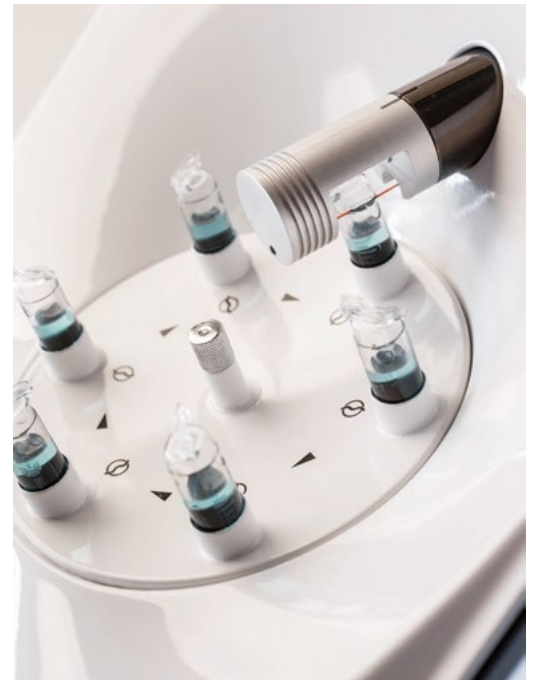

007218 MAPI

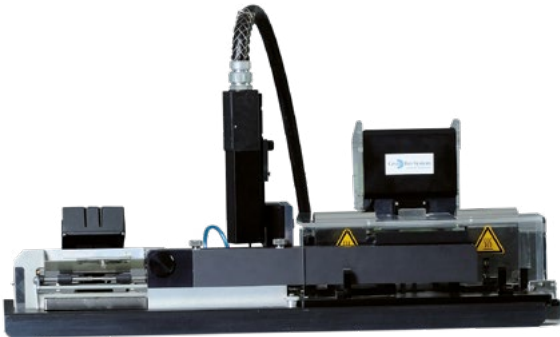

## DESCRIPTION

Automatic biological sample filling and identification system for CBS™ High Security straws.

From a primary tube, MAPI automatically fills, seals, prints out and validates the identification of CBS™ 0.3 or 0.5 mL straws (bar code or alphanumerical data).

MAPI features a filling robot, a control unit, a special liquid nitrogen ink-jet type printer and a PC with the MAPI pilot software. The robot is placed on a special lab bench at ergonomical height.

## TECHNICAL CHARACTERISTICS

- MAPI  
Dimensions (L x W x H): 760 x 260 x 470 mm  
Weight: 35 kg
- Worktop  
Dimensions (L x W x H): 1200 x 600 x 900 mm  
Height with machine: 1260 mm  
Weight with machine: 102 kg
- Control unit  
Dimensions (L x W x H): 430 x 380 x 190 mm  
Weight: 14 kg
- Domino printer  
Dimensions (L x W x H): 650 x 450 x 375 mm  
Weight: 20 kg  
Active printer vapor extractor duct, not included (diameter: 80 mm)  
Power supply:  
110 or 220 V / 60 or 50 Hz

Medical  
Device  
Classe IS

007454	Sterile CBS™ injection tubing	50
018620	Box of long blue sterile CBS™ injection tubing	25
007451	Sterile CBS™ aspiration tubing	50
014623	Non sterile injection tubing	200
018276	Non sterile long blue CBS™ injection tubing	200
014621	Non sterile aspiration tubing	200

# PACE

- 018451 PACE 220 V / 50 Hz
- 018450 PACE 110 V / 60 Hz

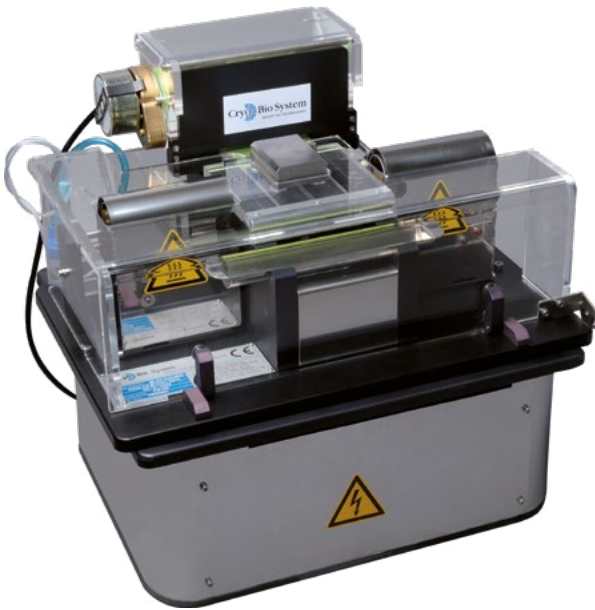

## DESCRIPTION

Semi-automatic system for filling biological samples into CBS™ High Security straws.

From a sample primary tube, PACE fills CBS™ High Security straws and automatically seals both ends of CBS™ High Security 0.3 or 0.5 ml straws, which can be pre-identified.

PACE is the ideal CBS™ robot for medium to large-scale projects with preset archiving protocols. PACE is compatible with CBS™ High Security straws - pre-printed or not - with bar code or alphanumeric code.

The system comprises a filling and sealing unit with control unit.

## TECHNICAL CHARACTERISTICS

- PACE  
Dimensions (L x W x H): 380 x 300 x 370 mm  
Weight: 25 kg
- Control Unit  
Dimensions (L x W x H) : 410 x 365 x 155 mm  
Weight: 14 kg

Power supply:  
110 or 220 V / 60 or 50 Hz

EQUIPMENT

007454	Sterile CBS™ injection tubing	<div style="border: 1px solid green; border-radius: 50%; padding: 5px; display: inline-block;">                     Medical Device Classe IS                 </div>	50
018620	Box of long blue sterile CBS™ injection tubing		25
007451	Sterile CBS™ aspiration tubing		50
014623	Non sterile injection tubing		200
018276	Non sterile long blue CBS™ injection tubing		200
014621	Non sterile aspiration tubing		200

## 027807 Integral HSV Vitrification unit



### DESCRIPTION

The INTEGRAL HSV vitrification unit is designed for vitrification, packaging and opening of CBS High Security straws in Reproductive Biology Laboratories.

### TECHNICAL CHARACTERISTICS

Width: 283 mm

Length: 487 mm

Height: 265 mm with cover, 222 mm without

Chamber volume: 5L

Weight : 5 kg

## 027636 Box of 5 opening devices for CBS™ High Security Vitrification straw

## 022406 Opening tweezers for CBS™ High Security Vitrification straw CBS™

### Blister of 4 CBS™ High Security Vitrification straws

Red	White	Yellow	Pink	Blue	Green
025246 ●	025247 ○	025248 ●	025249 ●	025250 ●	025251 ●

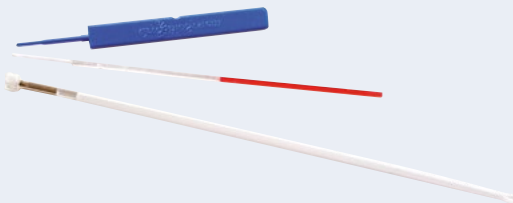

### DESCRIPTION

The High Security Vitrification straw is made of ionomeric resin, a capillary tube with a clear runner, co-injected with its colored handling rod, and a blue insertion device.

**For more information: p. 10-11**

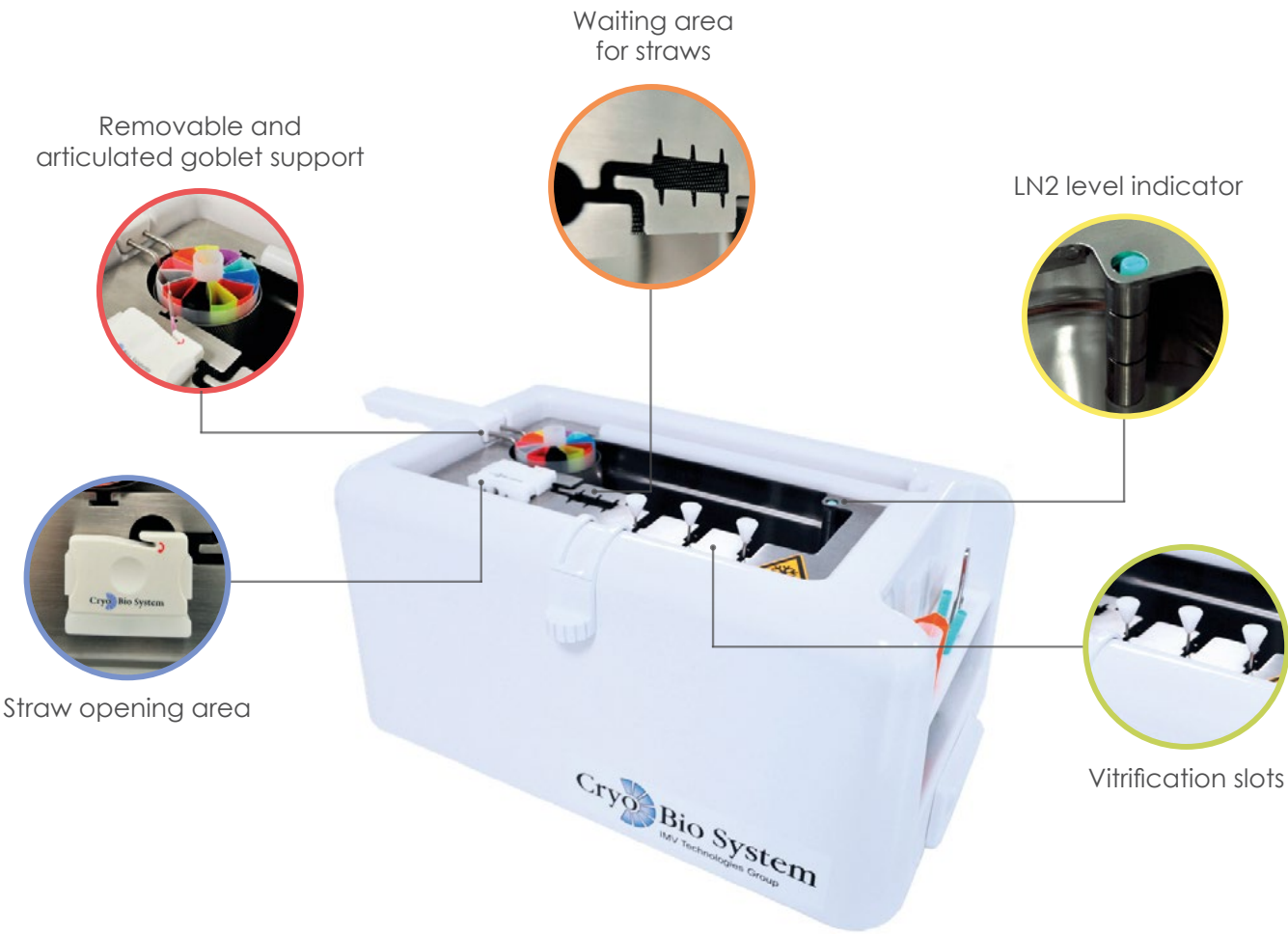

EQUIPMENT



**SECURITY**

Our vitrification bath offers more security for the user with a lower risk of nitrogen burns. It also offers more security for the sample by offering an uninterrupted cold chain.



**CENTRALIZATION**

All the actions are carried out in the bath: pre-cooling, vitrification, storage in visotubes and goblets and straw opening.



**USABILITY**

The vitrification bath allows more mobility within the laboratory. It is easily disassembled and can be cleaned for optimum hygiene.

**GAIN OF 50.7 % OF THE COOLING PHASE VELOCITY\***  
with the use of our High Security Vitrification straws

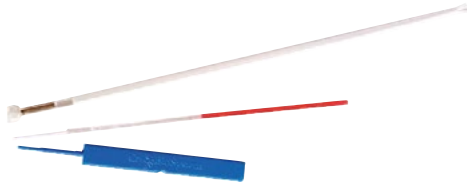

\*Tests performed internally, available upon request

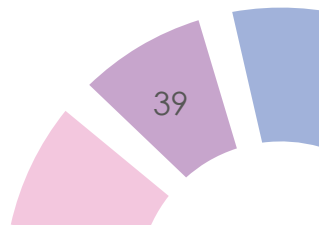

- 029530**    **ULISS (including 1 soldering block & 1 control box)**
- 029761**    **User manual**
- 029775**    **ULISS – Welding jaws –X 4**



## DESCRIPTION

The ULISS welding module is a semi-autonomous system, meaning it requires mandatory integration into a laboratory liquid handling system (LHS). Once installed and configured, this module enables the simultaneous and hermetic welding of two high-security CBS™ tubes in an automated manner.

By integrating into an LHS, the filling, welding and identification (primary and secondary) steps are carried out in a safe manner.

## TECHNICAL CHARACTERISTICS

- Welding module – Dimensions (L x W x H) : 468 x 153 x 116 mm – Weight : 5 kg
- Control box – Dimensions (L x W x H) : 482.6 x 177 x 425 mm – Weight : 12 kg
- Supply voltage : 230V ±10%
- Frequency (in Hz) : 50 Hz
- Power : 920 W
- Rate/Capacity: 2 CBS™ High Security tubes – up to 400 tubes/h\*
- Standards/Regulations : NF EN IEC 61010-2-030, Directive 2014/30/EC and 2006/42/EC

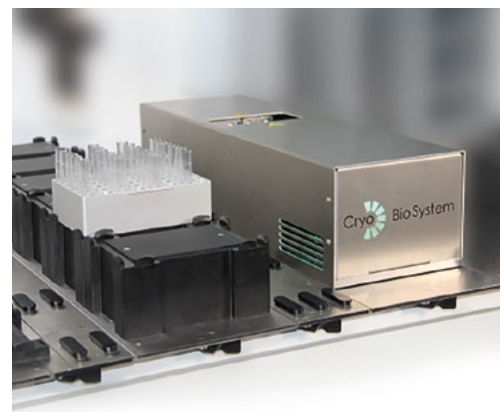

\*Depending on LHS configuration and number of integrated ULISS modules

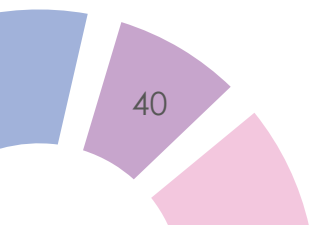







Connected to... **LIFE SCIENCES**



[www.cryobiosystem.com](http://www.cryobiosystem.com)

[contact@cryobiosystem-imv.com](mailto:contact@cryobiosystem-imv.com)

Cryo Bio System  
ZI n°1 Est  
61300 L'Aigle  
+33 (0)233 346 464  
[contact@cryobiosystem-imv.com](mailto:contact@cryobiosystem-imv.com)

NIFA Technologies, Pallasweg 22,  
8938AS Leeuwarden  
+31 58 2123279  
[www.nifa.nl](http://www.nifa.nl)  
[info@nifa.nl](mailto:info@nifa.nl)

Cryo Bio System USA  
9501 Louisiana Avenue North, Suite  
300 Brooklyn Park, MN 55445  
+ 1 763-488-1881  
[contact@imvusa.com](mailto:contact@imvusa.com)

Cryo Bio System India  
Plot No 750, Phase V, Udyog Vihar  
Gurgaon 122016 (Haryana)  
+91 124 477 07 07  
[contact@imvindia.com](mailto:contact@imvindia.com)

Cryo Bio System China  
Room 510, Building 1,  
No. 800, Naxian Road,  
Pudong District, Shanghai,  
China 201203  
[contact@imvchina.com](mailto:contact@imvchina.com)  
+86 400 066 3511

Leja  
Luzernestraat 10  
2153 GN Nieuw-Venep  
Pays Bas  
+31 (0)252-621 848  
[www.leja.nl](http://www.leja.nl)  
[info@leja.nl](mailto:info@leja.nl)